

Honor Solar

HY-M12/150

HY-M12/150H

Monocrystalline Module

485-505W

Cell Type



10BB(210mm)

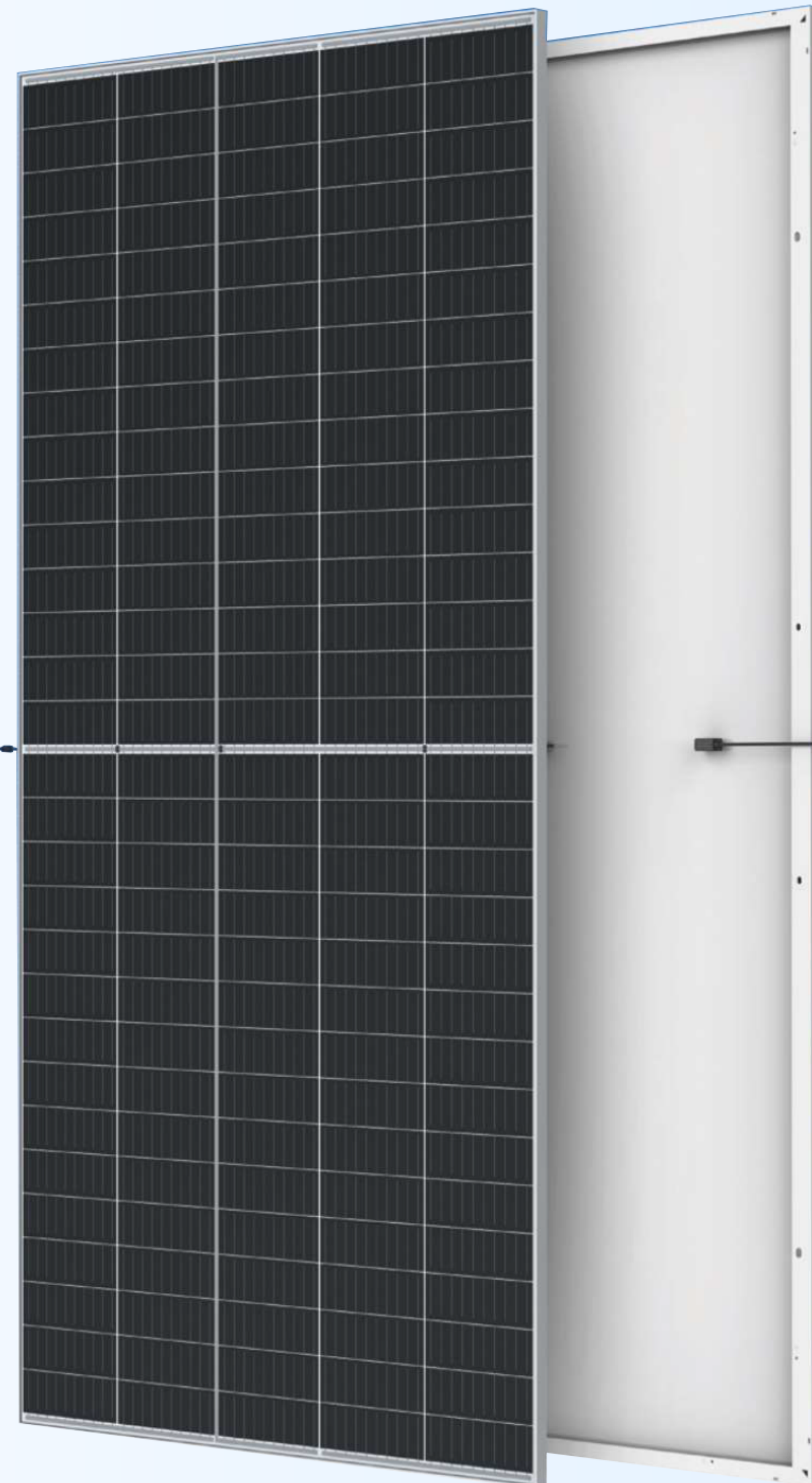

505W

Maximum Power Output

21.1%

Maximum Module Efficiency

0~+5W

Power Output Guarantee



Ideal choice for large scale ground installation



Selected encapsulating material and stringent production process control ensure the product is highly PID resistant and snail trails free



Special cutting and soldering technology leads to low hot spot risk



Sand blowing test, salt mist test and ammonia test passed to endure harsh environments



Optimized system performance due to module level current sorting



Highly transparent self-cleaning glass brings additional yield and easy maintenance

Delivers Reliable Performance Over Time

- manufacturer of crystalline silicon photovoltaic modules
- Fully automatic facility and world-class technology
- Rigorous quality control to meet the highest standard: ISO9001:2015, ISO14001: 2015 and OHSAS: 18001 2007
- Tested for harsh environments (salt mist, ammonia corrosion and sand blowing test: IEC 61701, IEC 62716, DIN EN 60068-2- 68)
- Long term reliability tests
- 2x100% EL inspection ensuring defect-free modules

Linear Performance Warranty

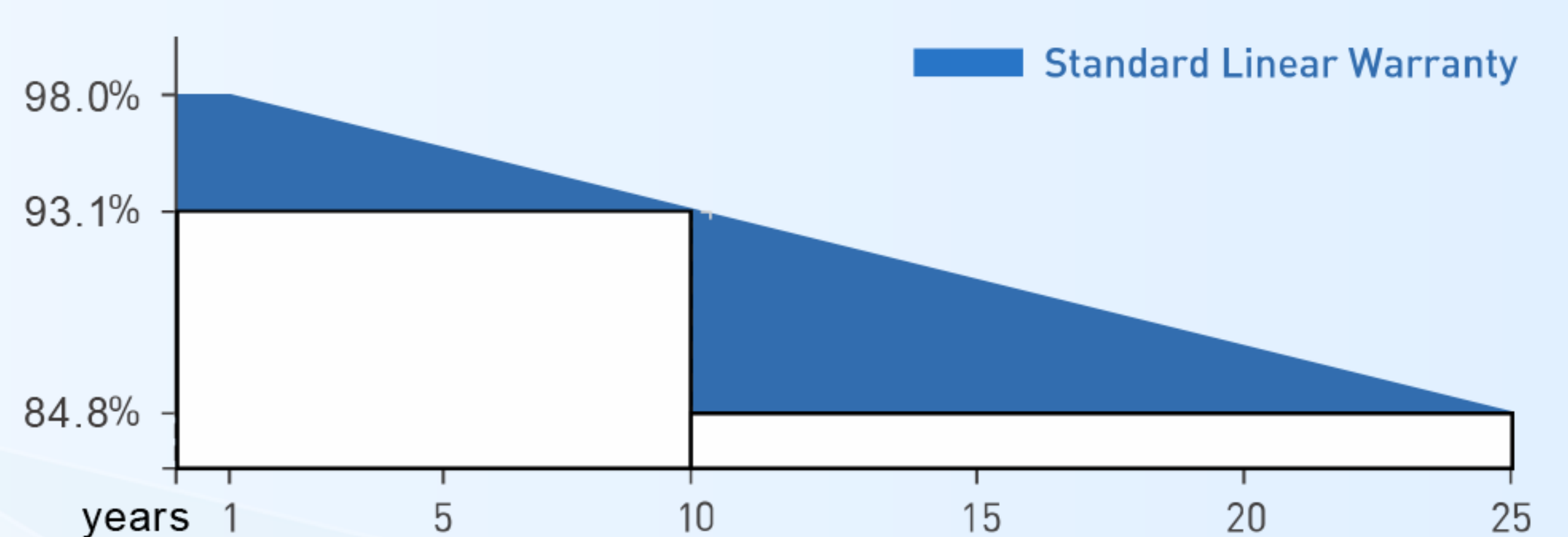

10 Years Product Warranty 25 Years Linear Power Warranty

* Please refer to standard warranty for details

Product certification



HY-M12/150 HY-M12/150H

Monocrystalline Module

485-505W

Electrical Specification (STC*)

		485	490	495	500	505
Maximum Power	P _{max} (W)	485	490	495	500	505
Maximum Power Voltage	V _{mp} (V)	42.2	42.4	42.6	42.8	43.0
Maximum Power Current	I _{mp} (A)	11.49	11.56	11.63	11.69	11.75
Open Circuit Voltage	V _{oc} (V)	51.1	51.3	51.5	51.7	51.9
Short Circuit Current	I _{sc} (A)	12.07	12.14	12.21	12.28	12.35
Module Efficiency	(%)	20.3	20.5	20.7	20.9	21.1
Power Output Tolerance	(W)	0~+5				

* Irradiance 1000W/m², Module Temperature 25°C, Air Mass 1.5

Electrical Specification (NOCT*)

		367	371	375	379	382
Maximum Power	P _{max} (W)	367	371	375	379	382
Maximum Power Voltage	V _{mp} (V)	39.8	40.0	40.2	40.4	40.6
Maximum Power Current	I _{mp} (A)	9.20	9.26	9.32	9.37	9.43
Open Circuit Voltage	V _{oc} (V)	48.2	48.4	48.6	48.8	49.0
Short Circuit Current	I _{sc} (A)	9.72	9.77	9.83	9.89	9.94

* Irradiance 800W/m², Ambient Temperature 20°C, Wind Speed 1m/s

Mechanical Data

Number of Cells	150 Cells (5×30)
Dimensions of Module L*W*H (mm)	2176×1096×35mm (85.66×43.14×1.38 inches)
Weight (kg)	26.3kg
Glass	High transparency solar glass 3.2mm (0.13 inches)
Backsheet	White
Frame	Silver, anodized aluminium alloy
J-Box	IP68 Rated
Cable	4.0mm ² (0.006 inches ²), 300mm (11.8 inches)
Number of diodes	3
Wind/ Snow Load	2400Pa/ 5400Pa*
Connector	MC Compatible

* For more details please check the installation manual

Temperature Ratings

Nominal Operating Cell Temperature (NOCT)	43±2°C
Temperature Coefficient of I _{sc}	+0.040%/°C
Temperature Coefficient of V _{oc}	-0.250%/°C
Temperature Coefficient of P _{MAX}	-0.340%/°C

Maximum Ratings

Operational Temperature	-40~+85°C
Maximum System Voltage	1500V DC -(H)
Max Series Fuse Rating	25A

Packaging Configuration

Module per box	30 pieces
Module per 40' container	600 pieces

Optional

Connector	MC Original
-----------	-------------

Module Dimension

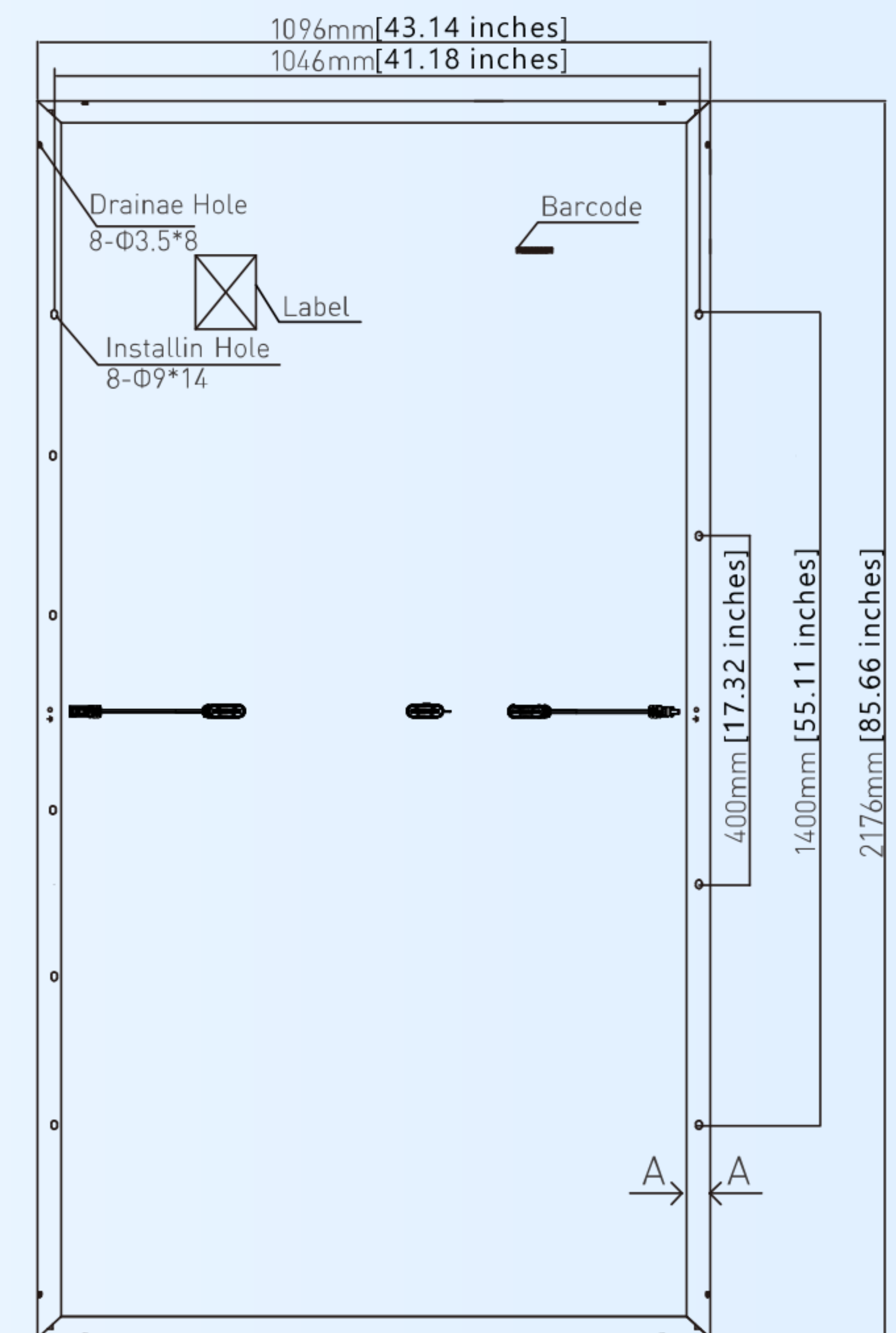

Back View

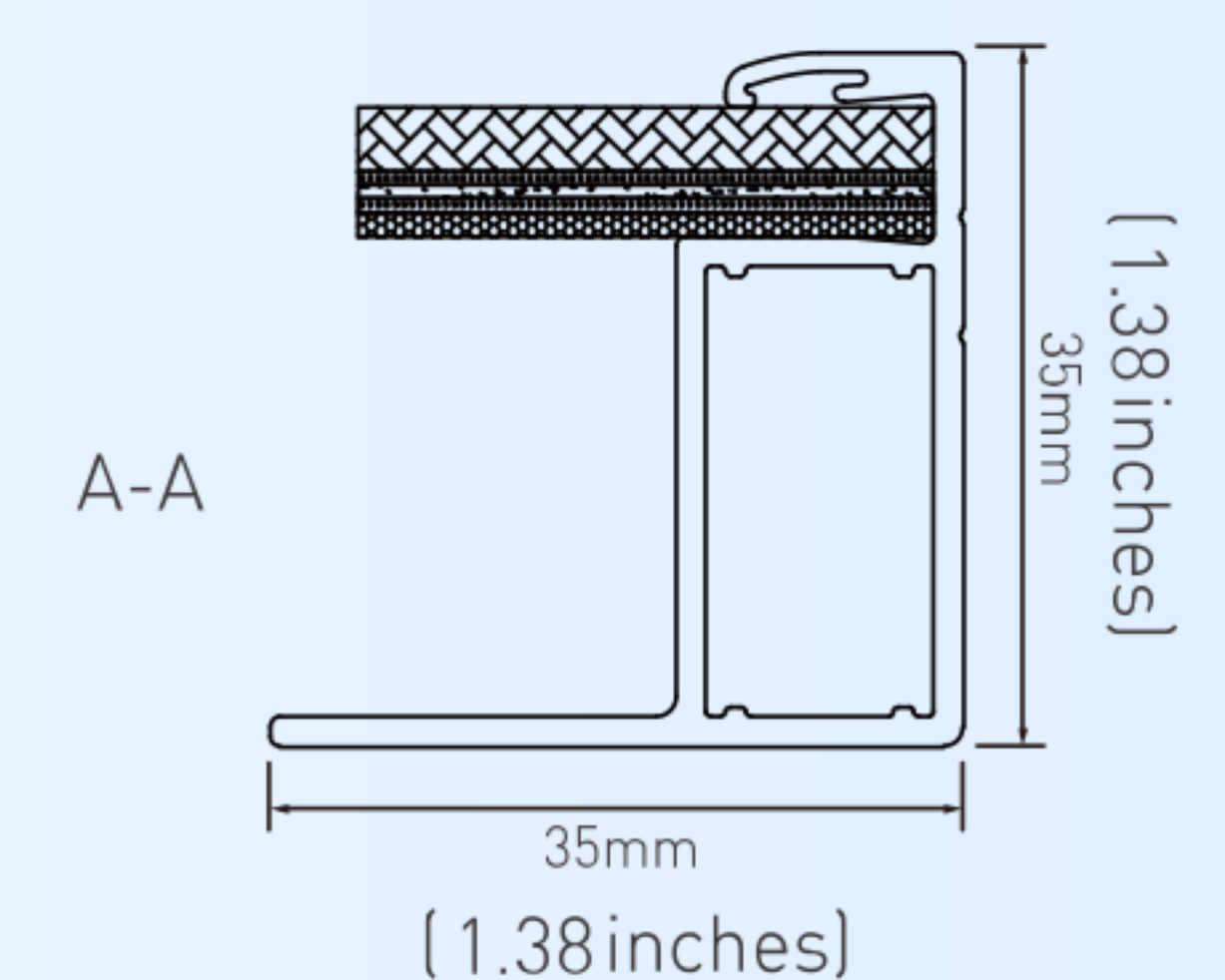

I-V Curve at Different Temperature (490W)

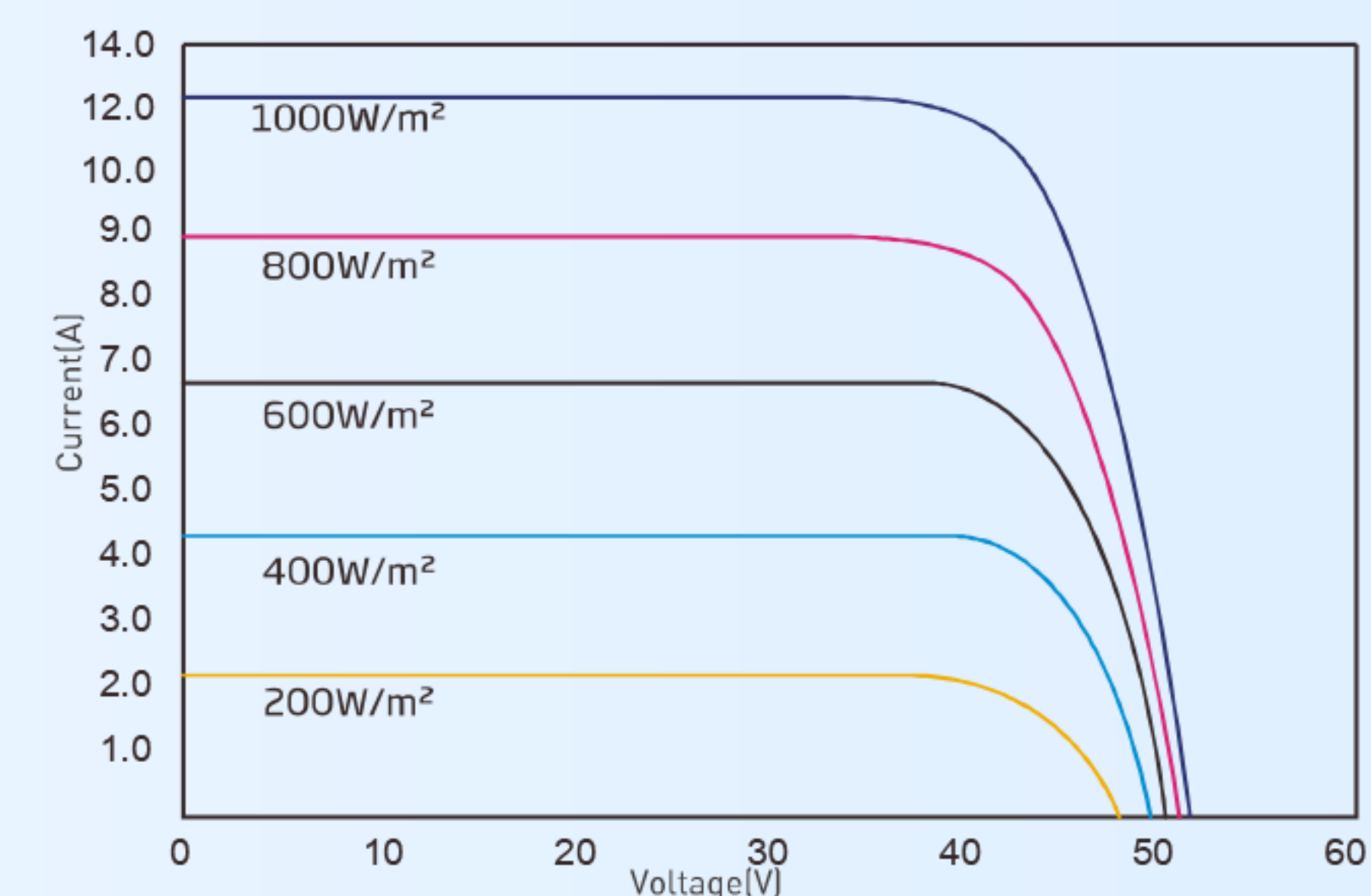

P-V Curve at Different Irradiation (490W)

